



Section 0

Exam Overview

Rev. January 29, 2024

Contents

INTRODUCTION	2
EXAMINATION HISTORY, STRUCTURE and SPECIFICATIONS.....	2
Structure of the Test	2
State/Province Sections	4
2023 FORMAT LARE SECTIONS	5
CLARB’s Test Specifications and Recommended Reading	5
Inventory, Analysis and Project Management (IAP)	6
Planning and Design (P&D)	7
Construction Documentation and Administration (CDA)	8
Grading, Drainage and Stormwater Management (GDSW)	9
Additional Suggested Study Material for all sections (in order of usefulness)	10
LARE Prep Google Group	11
Study Groups and Networking	11
Self Testing	11
Scaled Scoring	11
PREPARATION FOR THE LARE	12
Study and Exam Preparation Strategy	12
Knowledge, Skills, and Abilities (KSA)	13
Explicit and Implicit Requirements	14
STANDARD LARE QUESTION FORMATS.....	15
Standard Multiple Choice Format – select one	15
Standard Multiple Choice Format with Calculations	15
Standard Multiple Choice Format with Graphics	15
Standard Multiple Choice - Detail Evaluation Format (CDA Only)	16
Multiple Answer Format	16
Multiple Response Format	17
Use of Tables and Charts	18
Advanced Item Types (AITs) in the performance sections (P&D and GDSW)	18
List and Box	22
The Exam Interface	23
OTHER CONSIDERATIONS	24
Inappropriate Content for the Section	24
Take Practice and Reference Material with a Grain of Salt	24
TAKING THE LARE	26
Test Taking Tips	26
Dealing with Anxiety	26
Test Do's and Dont's	27
LARE Qualifier Words	28
OTHER IDEAS SUGGESTED BY SUCCESSFUL CANDIDATES	28
ETHICS	29
ORGANIZING YOUR STUDY TIME	30
ORGANIZING A SUCCESSFUL STUDY GROUP	30

INTRODUCTION

This overview has been prepared as part of the intensive preparatory course offered by SGLA Technical Training for the LARE (Landscape Architects Registration Examination). During the webinar, we review this general information about the LARE, followed by a detailed look at each of the many specific topics identified by CLARB (the Council of Landscape Architects Registration Boards) and a series of timed practice examinations.

The material collected here in Section 0 is free to all candidates, whether part of our webinar or not. You should always begin with CLARB's website. They have been doing a good job of keeping it up to date.

www.clarb.org

EXAMINATION HISTORY, STRUCTURE and SPECIFICATIONS

Structure of the Test

Every 5-7 years, CLARB conducts a survey of practicing landscape architects and uses this information to reorganize the LARE. New material is added and subject matter moved around between sections. CLARB tends to recycle old test graphics and questions, so our course includes some content that is quite old but that you may find is still baked into the core of the LARE.

The LARE has now reset to the new 2023 Blueprint. We expect this format to remain until around 2029.

Be aware that whenever CLARB reorganizes the LARE, the boundaries between the sections become somewhat blurred. It is likely that you will find topics on some sections of the test that seem to be in the wrong section. Adjust your study plans accordingly.

All sections of the LARE are now the same length and the same cost. All sections will have a mix of multiple choice/multiple answer and AIT/drag and drop question types.

30 minutes exam orientation, 3 hours exam time \$525 per section

CLARB will now be able to give some feedback on your performance by subdomain if you do not pass. We think these changes are good for LARE candidates.

Other Recent Changes

In January 2022, CLARB announced remote proctoring for all sections, and introduced changes to the exam that are intended to make the experience as fair and consistent as possible no matter where you take the exam. This change does make remote proctoring a more attractive alternative (by making the onsite experience more difficult, in my opinion.) They also switched from Pearson Testing to the more affordable (but less competent) PSI Testing. During the test periods of 2022, I heard of many problems, with both in-person and remote proctored exams. While most of these seem to have been resolved, we'll discuss those below so you can eliminate uncertainty before test day. I encourage you to keep an eye on the LARE Google Group as the test period begins.

The LARE is tested over a 12-day period and includes candidates from the US and Canada.

Onboard Whiteboard and Calculator

In 2022, CLARB introduced the onboard calculator and whiteboard. Some students have reported that the calculator is tricky, and that they found they needed to go slowly and verify each entry before proceeding or decimal points would get dropped.

In January of 2024, CLARB announced that candidates can now request a physical whiteboard and calculator if they are at a test center. This is a real advantage for people going to take the exam at a center.

If you are taking the exam from home, you will be required to use the onboard whiteboard and calculator. Practice using these tools as much as possible before test day – open the Demo Exam when you do practice exams and get used to them. This will be a difficult aspect of your exam but you can prepare.

You can try out the new format here. **Note that although the testing interface specifically allows you to rotate drag and drop elements, CLARB has come out and explicitly said you should not rotate elements.** Hopefully this wrinkle will be smoothed out soon. (If this link does not work, just search 'CLARB Demo Exam'.)

<https://portal-v5.examstudio.com/PLExam.aspx>

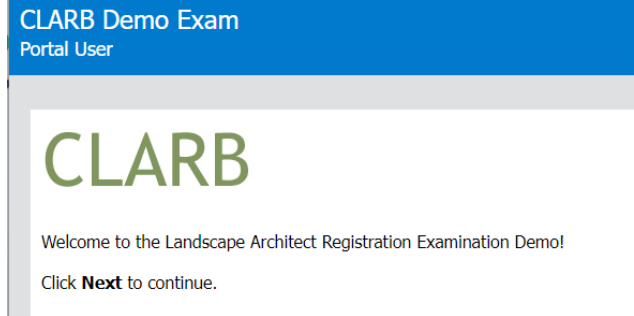

In-Person Testing with PSI

Traditional in-person testing has been switched over to a new partner, PSI, with the rationale that they can offer more test centers and better access.

CLARB has changed the rules around in-person testing in ways that will make your experience significantly more challenging. We think there is an advantage to going to a test center if you can – the physical calculator and whiteboard are significantly easier to use than the onboard tools.

- You will basically be taking the same exam as a remote proctored candidate, with the exception that you can request a physical calculator and whiteboard. Breaks are still permitted but **you will not be able to revisit any questions after a break.** You will be given an opportunity to review your answers and a warning before you take your break.
- The exam clock will continue to run while you take your break!!
 - ** Do your best to take the exam in one sitting with no breaks.
Have that big coffee after you finish the exam. **
- If you have a documented disability, you may be able to get extra time to complete your exam. You will need to apply ahead of time, so act sooner rather than later.
- PSI will not provide lockers. Do not bring anything to the test center except your 2 forms of ID – plan to leave everything else at home or in your car. We advise bringing your cell phone but CLARB's current website says not to. I think this will need to be worked out over time. We still advise that you bring the phone number for CLARB – maybe write it on a slip of paper.

CLARB main line: 571-432-0332 9 to 5 Eastern time, weekdays

Some candidates report that they have been allowed to put their things in a plastic bag that hangs over the back of their chair. You might want to visit your test center ahead of time to scope it out.

Some test centers/proctors seem to be worried about concealed devices hidden in clothing. Bulky sweaters might not be allowed. This is difficult if the room is kept cool. Wear thin layers if possible.

- They will provide sound-muffling headphones that some find quite uncomfortable. You can still bring foam earplugs and see if they will allow you to use them.
- Bring two forms of ID. Your name on the ID must match the name you used to register! Expired ID will not be accepted. Some proctors have rejected what seems like acceptable ID and you should have a backup if possible. CLARB lists these three forms of ID:
 - Drivers license
 - Valid passport
 - State ID card

Key Differences for Remote Proctoring candidates:

- Webcam and high speed internet are required and will be verified with a system check
- Plan for additional setup time. The proctor will ask to see the room you are working in and your desk must be clear, with your phone nearby but out of reach. This process may take 45 minutes.
- Some candidates have had good luck with covering the walls of their office with sheets to create an acceptable test environment without having to rearrange everything.
- Once the proctor has finished verifying your setup, you may need to sit and wait quite a while before your test begins – as long as 40 minutes more. Be patient and manage your mood.
- You must be visible on the screen at all times unless you take a break.
- **LARE remote proctor candidates** will not be permitted to use a handheld calculator and dry erase pads. **You will have to use the digital calculator and white board.** Cognitively, many people will find this quite difficult. I recommend you practice this skill ahead of time!
- Breaks are now permitted for remote proctored exams, with the same rules as in-person test center breaks. This is a good change – in the past, a few candidates have had to take unfortunate measures that we will not go into – test day is not the time to load up on coffee. However note that questions you have already read **will be locked** in both settings if you take a break (either at PSI or remote).
- No food or drink is permitted
- You will not be allowed to make any noise! You cannot read questions out loud. You cannot talk to another person in the room.
- You cannot stare off the screen for more than a moment at a time.
- After two warnings, your exam will be terminated.

I would not attempt remote proctoring without a rock-solid tech setup – relatively new computer, strong wifi, maybe even battery backup for your modem, monitor, and computer. It is your time and money, and CLARB can't be responsible for tech failures at your end. One candidate told me that she works for a federal contractor with very secure firewalls, and the test would not run from her office workstation. She was offered an in-person slot the next day but the experience was stressful. You may prefer to test from home.

Consider measures to protect your concentration if you test at home. You will not be able to get up to answer the door for deliveries or tend to pets. You will not be able to open a window or close blinds if the sun moves into your eyes. Once you start the exam you are stuck. Enlist a friend to mind the door or take pets out for the day. Tell people you will be unavailable by phone. Plan ahead to prevent as many disturbances as possible!

State/Province Sections

In some areas, after you complete all 4 sections of the LARE, you will need to take an additional test administered by your state or province. In Canada, you may be able to begin stamping drawings after passing two of the sections. There is a lot of local variation! Check with your local ASLA/OALA and state testing committee to confirm your province or state's requirements.

<https://www.asla.org/StateGovtAffairsLicensure.aspx>

California Supplemental Examination (CSE)

The section is a requirement for California candidates who have passed all 4 sections of the LARE. The California section is a 100-question multiple choice exam. The first opportunity to take this new exam was September 2007. It was revised in August 2011. Since we are based in California, we are developing a comprehensive review as an online course that can be done on your own time. The first three modules are live and available at sarahgronquist.com. We do not have prep courses for other states at this time.

2023 FORMAT LARE SECTIONS

CLARB's Test Specifications and Recommended Reading

The topic lists for the LARE can be found in CLARB's L.A.R.E. Orientation document. We have structured our prep material around these specs, as they provide the basic roadmap to the information to be tested on each section of the LARE. The best use of your time after our weekend is over will be using these lists and the references we give you to identify areas that need more study.

CLARB has updated their recommended reading lists (we reproduce them for each section below). Expect to be tested on these materials. Some are out of print. The LARE Google Group is a great resource for buying and selling secondhand copies.

<https://groups.google.com/g/lare-exam>

CLARB's stance on these references was clarified in 2023. Some topics that are identified by the Task Inventory are not covered in reference books. These are troublesome for candidates seeking definitive information.

"The reference material list has been prepared by the CLARB Examination Committee. While the Committee believes that mastery of the topics dealt with in the volumes on this list will be of assistance to you in preparing for the L.A.R.E., no representation is made that mastery of the topics dealt with by these volumes will ensure a passing grade on the examination, and no representation is made that the examination questions will be limited in scope to topics dealt with by the volumes contained on this list. Candidates are not expected to review all of the books on this list, as subject areas may be covered by several references. CLARB in no way guarantees that the contents of these references are accurate. Last modified September 14, 2023." CLARB

We recommend you seek examples of LARE topics in the real world, especially those not found in a book. Building a real-world, contextual understanding of the topics will also help you interpret the cryptic language in a typical LARE question.

Think about who is in your professional network. Can you borrow or review examples of plans or other documents from friends who work in offices that do different work than you do? Are you in contact with your local ASLA/OALA chapter? Do you have the bandwidth to organize or join a study group?

Remember everyone who has earned their license was in your shoes once. People are often more generous with their time than you may expect.

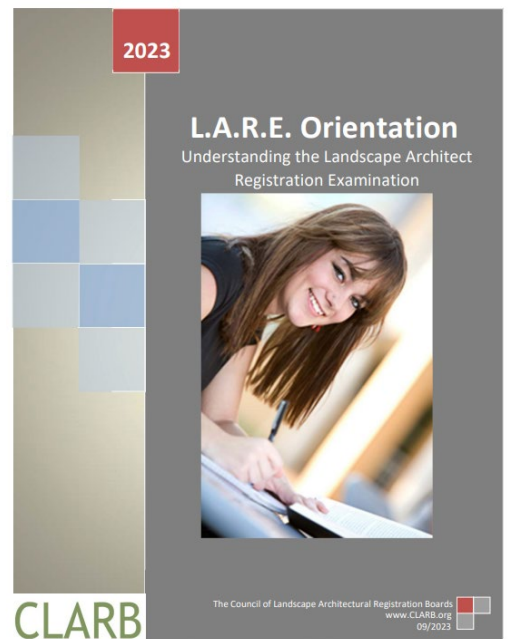

	Inventory, Analysis, and Project Management
	Planning and Design
	Construction Documentation and Administration
	Grading, Drainage, and Stormwater Management

Inventory, Analysis and Project Management (IAP)

Inventory, Analysis & Project Management – Updated 09.2023

90 scored items & 10 [pretest](#) items consisting of [multiple-choice](#), [multiple-response](#) and advanced [item type](#) questions; 3 ½ hours seat time, 3 hours for exam.



Project Management: 7%	Inventory and Data Collection: 21%	Stakeholder Engagement Process: 14%	Physical Analysis: 39%	Contextual Analysis: 19%
<ul style="list-style-type: none"> Develop and Manage Design Contracts Select and Manage Design Team Determine and Manage Design Scope, Schedule, and Budget 	<ul style="list-style-type: none"> Collect Related Policy Documents (e.g., municipal planning documents, proposed and existing land use maps, FEMA, EPA, stormwater management policies) Assimilate Information from Previous Planning Processes Conduct Onsite Investigation and Fieldwork Document Site Data Identify Adjacent Land Use Collect Contextual Data (e.g., natural systems, road networks, demographics, cultural and historical) Research Codes, Ordinances, and Permitting Requirements (e.g., site/project specific requirements) 	<ul style="list-style-type: none"> Identify Stakeholders Coordinate with Governing Bodies Support Public Participation Process (e.g., consult with clients, summarize feedback, communicate deliverables) Evaluate Design Based on Feedback Obtain Public and Private Approvals 	<ul style="list-style-type: none"> Determine Appropriate Types of Analyses Perform Vegetation Analysis Interpret and Review Soils and Geology (e.g., geotechnical, geology, soil map, soil characteristics) Perform Topographical Analysis (e.g., slope analysis) Identify Physical Opportunities and Constraints Perform Utility Analysis (e.g., capacity, availability, proximity, suitability) Analyze Existing Environmental Variables (e.g., contamination, erosion, air quality, water quality, micro-climate) Perform Circulation Analysis (e.g., multi-modal, access, non-motorized, connectivity) Perform Visual Resource Analysis (e.g., view sheds, view corridors, aesthetics) Perform Hydrological Analysis (e.g., floodplain, site drainage, water shed, surface, sub-surface) Review Ecological Analysis (e.g., habitat, biodiversity, ecosystems) 	<ul style="list-style-type: none"> Anticipate Impacts of Future Developments Identify Contextual Constraints and Opportunities Confirm Appropriate Use Conduct Code Compliance Review

CLARB Recommended Reading:



- **Planning & Urban Design Standards** - Student Edition/ Steiner and Butler
- **Site Planning & Design Handbook** - 2nd Edition / Russ
- **Sustainable Sites Handbook** / Calkins
- **Site Analysis**, 3rd Edition / LaGro
- **Project Management for Design Professionals** / Ramroth

If you do not know much about city planning, you will want to spend some quality time with *Planning and Urban Design Standards*. It is an important resource for this section.

Project Management was moved to this section in 2023. I would be familiar with *Project Management for Design Professionals*. The terminology and the many, many acronyms differ from my personal experience but the process and the issues as he describes them are spot-on. It is an easy, engaging read and you'll find a flash card deck I made for his terminology on Quizlet.

Other Recommended Material for this section:

This section is all about vocabulary. If you are not a native speaker of English, I recommend you drill with the flash card decks you'll find on Quizlet or Anki.

Indulge your curiosity in this section. Not sure what a view corridor or a Comprehensive Plan is? You'll find many publicly available city codes and projects on line. Many IAP topics are easier to understand by looking at actual examples rather than just reading about them.

Planning and Design (P&D)

Planning & Design – Updated 09.2023

85 scored items & 10 pretest items consisting of [multiple-choice](#), [multiple-response](#) and advanced [item type](#) questions; 3 ½ hours seat time, 3 hours for exam



Stewardship and Design Principles: 17%	Master Planning: 33%	Schematic Design: 28%	Design Development: 22%
<ul style="list-style-type: none"> Plan for Sustainability Plan for Climate Resiliency Plan for Environmental and Social Equity Recognize Historical and Cultural Significance 	<ul style="list-style-type: none"> Formulate Planning Goals (e.g., vision) Prepare Project Program (including budget) Synthesize Site Analysis Establish Opportunities and Constraints Determine Appropriate Land Use Develop Master Plan (e.g., conceptual plans, planning high level program elements, community planning, determine planning strategies) Evaluate Planning Scenarios Produce Planning Documents (e.g., land use, parks, open space, regional, historic, site master, corridor, blueways, greenways) Establish Design Guidelines Develop Phasing Plan Communicate Planning Outcomes 	<ul style="list-style-type: none"> Develop Design Intent Create the Basis for Design Prepare Functional Diagram Produce Conceptual Diagram Develop Schematic Designs Evaluate Design Alternatives Refine Selected Alternatives Produce Graphics, Illustrations, and Diagrams 	<ul style="list-style-type: none"> Refine Design Elements (e.g., material, circulation, lighting, utilities, planting) Determine Maintenance Implications Collaborate on the Design of Irrigation Systems (e.g., water conservation, sustainability, low water, gray water) Identify Required Approvals (e.g., regulatory permitting) Develop Opinion of Probable Costs (e.g., schematic, design development, revisions) Evaluate Value Engineering Alternatives Demonstrate Understanding of Legal Liabilities

CLARB Recommended Reading:



- **Landscape Architectural Graphic Standards** - Student Version / Hopper
- **Landscape Architecture Documentation Standards** / Design Workshop
- **Sustainable Stormwater Management** / Liptan and Stanten
- **Sustainable Sites Handbook** / Calkin
- **Site Planning and Design Handbook**, 2nd edition / Russ

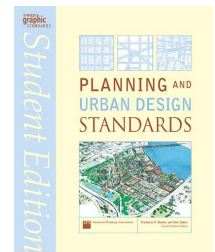

If you do not know much about city planning, you will want to spend some quality time with *Planning and Urban Design Standards*. Just like for IAP, it is an important resource for this section. CLARB's definition of 'design' relies heavily on HSW (Health, Safety and Welfare) and zoning concepts related to adjacencies.

The Sustainable Sites Handbook is a great resource for learning about sustainable alternatives in materials and processes. I would know the vocabulary and technical info it contains for this section.

Other Recommended Material for P&D:

Getting at what defines good design is difficult. You may enjoy Norman Booth's book *Basic Elements of Landscape Architectural Design*, especially if you need a refresher on basic design terms like 'rhythm' and 'texture'. Graphic-heavy and fun to look at. However... expect CLARB to avoid aesthetics and focus on HSW and compliance with laws and codes.

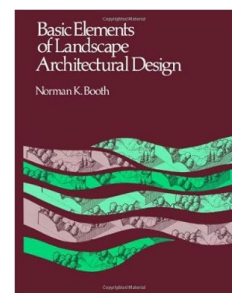

CLARB Sample Vignettes and Solutions from 2009. You may be able to find CLARB's old Section C practice vignettes if you look. (We also provide them as part of our study materials). They were provided when the exam used to be paper-and-pencil in 11x17 format. Not a bad resource if you have trouble understanding CLARB's definition of 'design'. The old vignette format has evolved into the AIT problems on the current exam.

Books from Professional Publications, Inc., Morrison Media, LLC are out of date (2007). While the old MM Section D vignettes are excellent for the GDSW section, the solutions given in the Section E book are terrible and fail to meet basic requirements. Use with caution and be skeptical of the 'right' answers. We discuss and analyze some examples in the webinar.

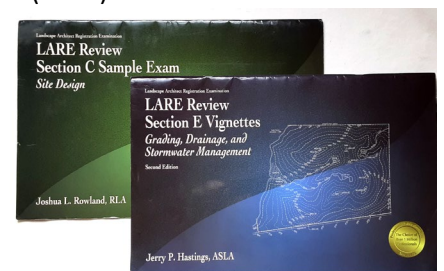

Construction Documentation and Administration (CDA)

Construction Documentation & Administration – Updated 9.2023

90 scored items & 10 pretest items consisting of [multiple-choice](#), [multiple-response](#) and advanced [item type](#) questions; 3 ½ hours seat time, 3 hours for exam



Construction Plans and Details: 50%	Construction Specifications and Bidding: 20%	Construction Administration: 30%
<ul style="list-style-type: none"> Identify Required Plan Sheets Produce Existing Conditions and Demolition Plan Produce Protection and Mitigation Plan Produce Layout and Materials Plan (e.g., site furnishings) Produce Planting Plans and Details Create Details, Elevations, and Sections (e.g., walls, pavements, structures, specialty features, green roofs, drainage details) Collaborate on Supplemental Plans (e.g., lighting, irrigation, playground, wayfinding) Develop General Notes, Schedules, and Legends Comply with Code Requirements and Dimensional Standards Perform QA/QC Activities 	<ul style="list-style-type: none"> Develop Project Manual and Front-End Specifications Establish Bid Requirements Write Technical Specifications Facilitate Bid Process (e.g., bid forms, meetings, delivery process) Respond to Bidders' Questions and Prepare Addenda 	<ul style="list-style-type: none"> Conduct Pre-Construction Activities (e.g., walk-through, meetings) Respond to RFIs Manage Construction Contract (e.g., budget items, change orders, bulletins, purchase requests, change directives) Review Submittals (e.g., shop drawings, materials submittal, product submittals, substitutions, mock-ups) Conduct Site Observations and Field Reports Perform Project Close-Out (e.g., punch-list, substantial completion, guarantee period, final completion) Perform Construction Project Management (e.g., roles and responsibilities, liabilities, scope, schedule, coordination with other disciplines, coordination with owner)

CLARB Recommended Reading:



- Construction Contracts**, 3rd edition / Hinze
- Landscape Architectural Graphic Standards** - Student Version / Hopper
- Time-Saver Standards for Landscape Architects**, 2nd Edition / Harris and Dines
- Landscape Architecture Documentation Standards** / Design Workshop
- Landscape Architects Portable Handbook** / Dines and Brown

Construction detailing and materials have been moved into this section, along with CDs, specifications, and construction administration. While the old Section 4 felt overstuffed, the new CDA (previously Section 1) now bulges with content. I would prepare for this section seriously, especially if you do not have much experience with construction administration or detailing.

Construction Contracts was heavily tested in the past, when this topic was weighted more heavily. Now it is split between early stage/IAP and late stage/CDA. Hinze is dense but you must know the vocabulary.

Landscape Architectural Graphic Standards and *Time Saver Standards* are very useful for this section. Know the graphics and the technical standards they contain.

Landscape Architectural Documentation Standards is a new addition to the list. It is wordy but has good, accurate information about issues related to assembling contract documents.

Other Recommended Material for CDA:

Greenstreet, Bob, Greenstreet, Karen, and Schermer, Brian, *Law and Practice for Architects*, Architectural Press/Elsevier, Burlington MA, 2005. Much clearer/ simpler than Hinze, same material.

Rosen, Harold, Kalin, Mar, Weygant, Robert, and Regener, John Jr, *Construction Specifications Writing*, 6th Edition, John Wiley and Sons, Inc, Hoboken NJ, 2010. CLARB does not provide a good reference for specifications. Here it is!

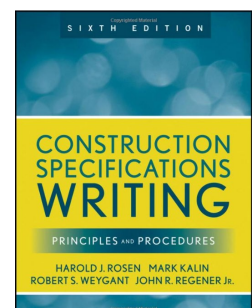
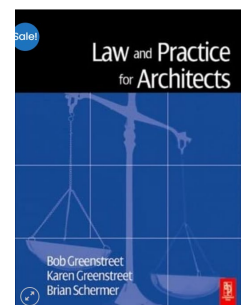

Grading, Drainage and Stormwater Management (GDSW)

Grading, Drainage and Stormwater Management – Updated 09.2023

70 scored items & 10 pretest items consisting of [multiple-choice](#), [multiple-response](#) and advanced [item type](#) questions; 3 ½ hours seat time, 3 hours for exam



Stormwater Management: 39%	Grading and Earthwork: 44%	Drainage Systems: 17%
<ul style="list-style-type: none"> Determine Watershed Area Determine Stormwater Management System Determine Pervious and Impervious Areas Develop Sustainable Water Quality Practices Select Surface and Sub-Surface BMPs Select Building-Systems BMPs (e.g., Green Roofs, Blue Roofs, Brown Roofs, Green Walls, Water Harvesting/Cisterns, Gray Water) Develop Erosion and Sedimentation Control Plan Obtain Approvals and Permits 	<ul style="list-style-type: none"> Adhere to Accessibility Standards Produce Large-Scale Grading Design (e.g., site, landforms, mass-grading, conceptual, preliminary) Produce Detailed Grading Design (e.g., place spot elevations, roadway profile, sidewalk profile, plaza) Review Grading Design (e.g., review grading alternatives, evaluate for inconsistencies) 	<ul style="list-style-type: none"> Prepare Drainage Plan and Profile (e.g., design/create a plan or profile) Design and Select Drainage Components (e.g., types of drains, selecting the appropriate components) Review Drainage Plans (e.g., evaluate existing design or design alternatives)

CLARB Recommended Reading:



- **Landscape Architectural Graphic Standards** - Student Version / Hopper
- **Time-Saver Standards for Landscape Architecture**, 2nd edition / Harris and Dines
- **Sustainable Stormwater Management** / Liptan and Stanton
- **Site Engineering for Landscape Architects**, 6th edition / Strom, Nathan and Woland
- **Sustainable Sites Handbook** / Calkins

The new GDSW is much more manageable than old Section 4, with large chunks of content relocated to CDA. Now we can really concentrate on Grading and Drainage! There is still a lot to prepare for.

Site Engineering for Landscape Architects is the best reference for this section, in our opinion. I would dig into the technical terminology and examples more deeply than you may have done in the past for old S4.

The Sustainable Sites Handbook is a good resource for practical information – less abstract than SELA.

Sustainable Stormwater Management is new to this section. I like this book and its commonsense approach.

Other Recommended Material for GDSW:

Valerie Aymer's book *Landscape Grading: A Study Guide for the LARE Grading Examination* is a great resource for practice problems. Aymer gives solutions with step by step explanations for many different types of grading problems. These are not in the current test format but I find them very useful for skill building and understanding grading for ponds, culverts, and other specific grading situations. A Second Edition was released in 2020 with new exercises and vignettes. I encourage you to seek it out if you are struggling with grading.

Books from Professional Publications, Inc., Morrison Media, LLC are out of date (2007). However, much of the material in them is still very useful if you want to build your pencil-and-paper grading skills. I recommend you make use of the Pass/Fail examples as well to sharpen your analyzing skills. Very good quality resource for this section.

Remember that the problems you may encounter moving forward from 2023 will be less complex than these problems! These should be used for skill building.

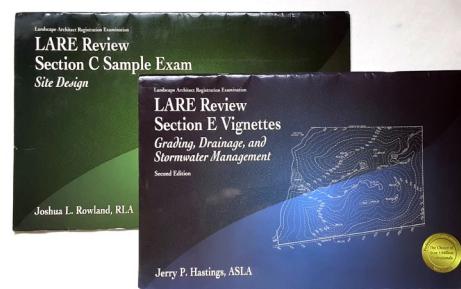
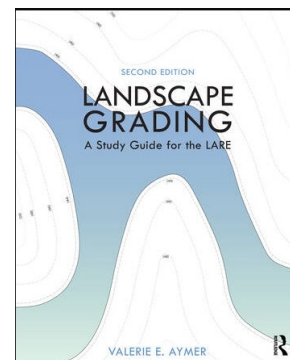

Additional Suggested Study Material for all sections (in order of usefulness)

CLARB 2023 Practice Exams

Each of these practice exams contains 50 retired questions from the LARE. They are in the 2023 Blueprint format and CLARB provides a rationale for each question so you can understand the most correct answer. I recommend you try these at the halfway mark in your studies, and use what you learn to refine your focus for the final push. You'll find them on the CLARB website.

Note: Exam prep folks (like me) are not allowed to access these. So I will not be able to answer questions about them. Practice exam content is confidential.

Exam Overview Videos from CLARB and the ASLA

There are at least three videos. Type in 'LARE Exam' once you are in YouTube to find them. Two are about ten minutes long, the other is 44 minutes. Names are: LARE34, LARE Demonstration 2012, ASLA LARE Video

<http://www.youtube.com/>

Digital Flashcard Programs

I recommend drilling vocabulary for all students, but especially if English is not your native language. If you know the meaning of key words in questions, you have a much higher chance of guessing the correct answer. You will find decks made by previous LARE candidates if you search.

Quizlet – Graphically sophisticated, easy to use. You'll find some decks that I have made from glossaries of CLARB's reference books - search *LARE SGLA*. Many other existing LARE decks to work with.

<https://Quizlet.com>

Anki - A little more bare bones but will generate targeted quizzes for you, repeating questions you miss.

<https://apps.ankiweb.net/>

LAREprep is a private company that offers study guides and online practice tests that are similar in format to the 2017 testing format. The material appears to be good and I see evidence that they regularly update the materials. Each test allows you access for 90 days. They cost between \$22-28 per test.

<https://www.lareprep.com/>

Pass the LARE is a newer company that also offers online practice tests. These tests also seem to be good quality and provide more opportunities to practice your knowledge. I know the developer is continuing to update and refine. Several exams for each section, cost for each is \$35 and grants you 90 days access.

<https://passthelare.com/>

"The Landscape Architect Registration Examination: A Step by Step Guide." You may find someone who has this 2008 CLARB booklet. It contains 30 sample questions for sections A, B and D. The questions are pretty old now but still valid as examples of the subject matter.

CLARB's 2000 Road to Licensure and Beyond also has multiple choice questions and old graphic format questions. While this material may be out of date, it may prove useful.

Other Internet Resources

This Google Drive link includes some old sample tests and prep materials for the LARE. Some of it is quite dated. The most valuable info is sample exams produced by CLARB. There are also some sample tests from the Georgia Chapter LARE Review by faculty at the Univ of Georgia.

<https://docs.google.com/folder/d/0BzvCltdSSIQwOTFXSHpGMG5abWc/edit>

Shake & Bake Publishing materials are out of date, and not well written. **Not** recommended.

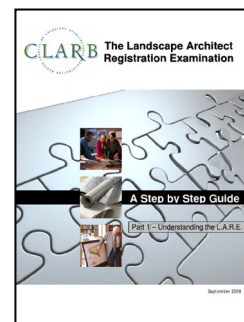

Other Resources and Advice

LARE Prep Google Group

This online group is a great place to ask questions, find study partners, purchase used books, share intel about your experiences with test centers, and get moral support. Be aware that this is a public forum and it has been shut down in the past due to students sharing specific test questions. Keep information general.

<http://groups.google.com/group/lare-exam?lnk=>

Study Groups and Networking

In the webinar, I invite everyone to form a study group at the end of the weekend. During COVID, remote meeting apps made it much easier to study with people who have a broad set of experiences. You will find that studying with professionals who practice in different climates, at different scales, and for different client types turbocharges your understanding of the scope of the LARE. It is very difficult to understand how much climate and project type can change a design approach without discussing it with others.

Past study groups have used Slack, Zoom, or Google resources (Docs, Sheets, Hangouts, etc) to meet regularly and have reported that it is an extremely valuable tool. If you are not taking our webinar, I encourage you to use the Google group or your local ASLA to form a virtual study group.

Self Testing

Taking multiple choice tests, using CLARB's online whiteboard and calculator, in an uncomfortable place, under time constraints is a good way to acclimate yourself to the exam in advance. The demands of the LARE are quite different than what most of you have experienced in school or in your jobs, **I can not emphasize enough how important it is to simulate the experience of the LARE in advance.**

Take your laptop to a public place and practice working from the screen with digital calculator and whiteboard tools in a distracting environment. Put some time pressure on yourself and practice staying calm and focused. Many candidates say time stress is a significant distraction during the exam.

Scaled Scoring

CLARB applies statistical analysis to all the sittings of the LARE in order to provide the most consistent exam possible. This means that the relationship between the number of questions you answer correctly and the score you receive is a total mystery. For what it's worth, here's what they say in the Orientation Guide:

Exam Results Reporting

Exam results for all sections of the L.A.R.E. are not reported immediately after completing the exam due to the analysis performed on the items to ensure that the items are correct, fair and accurately address the subject matter being tested. CLARB's testing experts look at the difficulty of the items, the response patterns by candidates and the ability of the items to discriminate between candidates of differing ability levels.

Exam results for all sections of the L.A.R.E. will be available on the CLARB website approximately 6 weeks after the last day of the exam administration.

Exam results are reported as pass or fail. If a "Fail" result is received, a number representing a scaled score will also be received. The scaled score provides candidates with a performance indicator demonstrating how close they were to the passing point. For each section, candidates must obtain a scaled score of at least 650 to pass. A scaled score of 640, for example, would indicate that a candidate was close to passing.

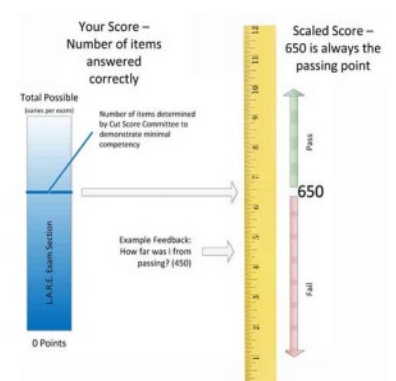

PREPARATION FOR THE LARE

The LARE is different from anything else you will experience in your career as a Landscape Architect. The exam is designed to test your level of competency for licensure, not your talent. The time limits for completing the sections place a premium on experience and fluency with various facets of the profession.

Landscape Architecture is not a job, it is a profession. Some established standards of practice are simple to describe and perform. Others are unwritten and difficult to pin down. The first group of standards can usually be found in reference manuals on CLARB's list. The second group is more about how we approach our work, how we conduct ourselves professionally, and how our competence and professional worth is judged by our clients and colleagues. The LARE is an attempt to objectively evaluate your Knowledge of standards, your technical Skills, your professional Abilities at problem solving, and your ability to apply these KSAs to real world issues.

Study and Exam Preparation Strategy

The exam is divided into sections dealing with different aspects of practice. CLARB says that proficiency is evaluated by an objective, consistency-based procedure. Proficiency is also evaluated by timed applications of knowledge, skills, and abilities. Objective questions and individual performance problems are crafted to be adequately completed within a certain time period, if the candidate is proficient.

Time constraints can be tight. Good time management during the exam is critical for success.

You should therefore have two broad goals for your study strategy:

- Know the content of the exam well enough to answer the questions and solve AIT (Advanced Item Type) problems efficiently.
- Know the format of the exam well enough to apply your knowledge efficiently.

Not everyone processes and retains information in the same way. Some people read and retain, while others learn by doing. Part of your self-evaluation should be a look at your personal learning style. Understanding how you study can help in scheduling your exam preparation, finding appropriate study materials, and deciding what resources are most appropriate and efficient for your needs.

The three most important elements for passing the LARE are:

1. Fluency and experience within each subject area of the exam.
2. Developing and maintaining a positive attitude towards test-taking in general and the ability to deal effectively with test-taking stress. In other words, remain calm and focused during the exam. Develop an anxiety-reduction routine to use during the test in case you need it.
3. Developing the ability to keep written instructions and information in context, treating each problem statement as a complete task.

Keeping the above elements in mind, focus your preparation on the following activities:

- Gather and consult necessary information sources and reference materials.
- Understand the rules of the LARE.
- Study, referring to the CLARB specifications for your section.
- Use your study group to assess your preparation with timed practice tests and follow up discussions. Your study group partners will have valuable experience and insights.

Place some emphasis on the following:

- Your weak areas
- Areas given priority by the Exam Specifications
- Books with overviews of general principles and theories
- Books with glossaries of terms
- Books listed in CLARBs recommended references.
- Applied knowledge - the whys and hows of using information as a problem solving tool

Consider building a reference library. You can buy and sell books through the Google group or your local ASLA. If you have not worked within the traditional design process, you would benefit from a text which describes the intent and methods of the process, because both the exam content and the format are based on the nomenclature and application of the simple process (site selection, inventory and analysis, functional diagrams, conceptual design, preliminary design, design development, details, documentation, grading and drainage and other aspects of traditional practice).

Balance your study time realistically: spend thirty minutes or more every day reading text, and spend concentrated blocks of time once a week on practice problems and review of your notes. In addition to memorizing basic formulas, definitions, and other specifics, use the references to understand the fundamentals behind the formulas and their application. Your understanding of these principles and your ability to apply them will be tested in several ways. Objective questions and performance problems will require "instant recall" of these principles to solve a variety of problems quickly. See our other study tips at the end of this Section 0 document.

It is very helpful to make a simple study plan. How many weeks do you have? Make a simple plan assigning topics from CLARB's list to each week so that you will cover every one by the time your exam day arrives.

Do not rely on last minute "cramming" to get you through the exam. As you may remember, this didn't work so well in college and it definitely **WILL NOT WORK** with the LARE. The exam material is too broad and the test too comprehensive to cram it all in a week or two. Immerse yourself gradually but fully in your study material and practice, practice, practice the AIT format problems for P&D and GDSW.

Knowledge, Skills, and Abilities (KSA)

Every 5 to 7 years, CLARB mails an exhaustive survey to 6,000 licensed landscape architects in the United States and Canada. The results are compiled into the CLARB Task Analysis, a book which includes the practice type, ages, demographics, and other data about the respondents, and the summary of the data. This book is a comprehensive list of the tasks which licensed landscape architects have described as both important to the practice of a minimally competent landscape architect, and as tasks which are frequently performed in the practice of landscape architecture. These tasks are described as "knowledge, skills, and abilities," and they are most often referred to as KSAs.

For the candidate, the detailed lists of the KSA in the CLARB Task Analysis, which have been distilled and listed in the LARE Examination Specifications (see Appendices) are the core material of the LARE.

Some KSAs are so important that they will be tested in more than one section of the exam. The Task Analysis survey respondents rate the tasks on a 0 to 5 scale; 0 means the task is not important or not performed frequently by the minimally competent landscape architect. Obviously, the higher the score, the more likely the task needs to be tested in the LARE.

For example, one obviously important and frequently performed task is "ability to interpret base plan information, topographic or other surveys." Because of its high importance score, there may be more questions about this KSA than any others.

KSA Categories

Knowledge: Do you know this or not?

Applied: Use knowledge to solve a problem.

KSA Examples

- An objective question with a graphic illustration of topographic contours asks the candidate to identify specific land forms. (IAP, P&D, GDSW)
- Perform a quick cost estimate. (IAP, CDA)
- Be able to identify the proper sequence of stages in the design process, or know what tasks are typically performed within each stage. (IAP, CDA)

- Answer questions about design principles. (P&D)
- Be familiar with a wide variety of resource conservation topics such as ecological planning principles, floodplain management and wetlands mitigation. (IAP, P&D, CDA)
- Be familiar with a variety of standard construction materials, their properties, and how they might be used. (CDA, P&D)
- Given a site, choose where to site various program elements to best meet site opportunities and constraints. (P&D)
- Identification of opportunities and constraints based on topographic maps, soils information, or other on or off-site features. (P&D)
- Identify alternative designs for a program, evaluate alternatives and/or select a preferred alternative. (P&D)
- Identify on a site plan where pedestrian-vehicular conflicts are most likely. (P&D)

These examples are given to illustrate that knowing the KSAs will help you streamline your study time and evaluate your strengths. You can use the KSAs as a section-by-section checklist for you or your study group.

Explicit and Implicit Requirements

It is impossible for CLARB to set down every single thing a landscape architect should know. There are explicit and implicit expectations. Individual problem statements, and the LARE Reference Manual contain explicit directions and expectations that are clear, precise, and specific.

Explicit requirements direct you to perform certain actions or to place emphasis in specific areas. You need to read the problem statements carefully and select the most appropriate answer from those available. You may not believe any of the available answers are “correct”, however you can only use the available answers. On the LARE explicit requirements are spelled out in the problem statement

Beyond those are unwritten, implicit expectations of what a Landscape Architect should reasonably be expected to know without having to be reminded of their importance.

Implicit requirements may include:

- Anything to do with the Health, Safety and Welfare of the general public.
- Compliance with regulations and codes.
- Minimizing adverse environmental impacts.
- Developing sites and using materials efficiently and cost effectively.

Three critically important implicit requirements of the exam are:

- You will carefully read, understand and base your answer on the problem statements and contextual information on the exam.
- You will understand the material in the LARE Orientation Guide and know how to use any charts, tables, and materials in it that apply to the objective sections of the exam.
- A minimally competent landscape architect should not have to be reminded to provide solutions that are safe, efficient, and reasonable.

STANDARD LARE QUESTION FORMATS

This information is based on the LARE practice exams and information provided by CLARB. The Candidate Orientation Guide on CLARB's website is constantly updated, and is a great place to start.

Standard Multiple Choice Format – select one

1. Three reasons an easement may be created include:
 - A. Public outreach, access, and wildlife corridors
 - B. Pro forma, utilities and timber harvesting
 - C. Access, signage and marketing
 - D. Open space, access and utilities

Answer: D

Standard Multiple Choice Format with Calculations

2. Given the following coordinates of two points, what is the horizontal distance between these points?

Point #1	North 1000	East 500
Point #2	North 850	East 625

- A. 195 feet
- B. 548 feet
- C. 275 feet
- D. 175 feet

Answer: A

Standard Multiple Choice Format with Graphics

3. Which of the following is not a standard graphic symbol for the corresponding item?

- A. +100.0 Existing Spot Elevation
- B. DI Drain Inlet
- C. - - - - 30 - - - - Existing Contour Line
- D.  - - - - Property Line

Answer: A

4. Which of the following grading and planting schemes is suitable for a cold, high elevation site?

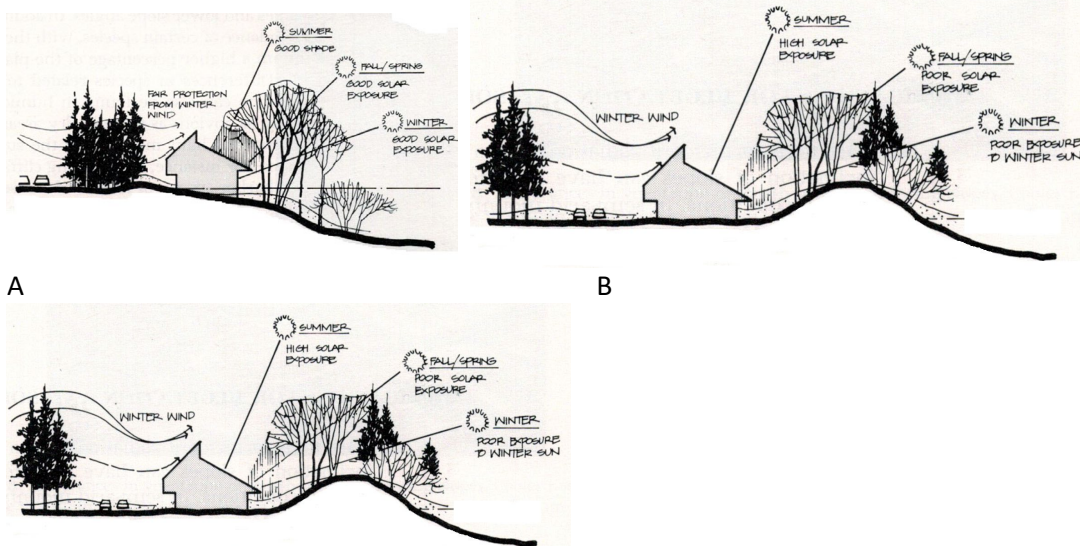

C
Illustrations from Marsh: *Landscape Planning*

Answer: A

Standard Multiple Choice - Detail Evaluation Format (CDA Only)

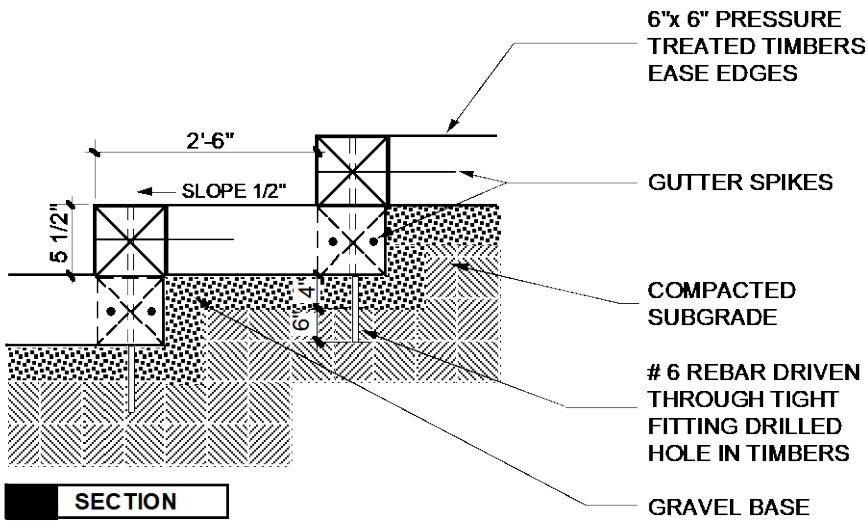

5. Which of the following is the most correct statement concerning the detail shown?
- A. The detail is correct.
 - B. Base thickness is not appropriate (too thick or too thin).
 - C. Timber dimension is not appropriate.
 - D. Subgrade is inadequately prepared.
 - E. Riser height is not appropriate.
 - F. Slope on tread is inadequate.
 - G. Fastener is inappropriate.
 - H. Expansion joint required but not shown.

Answer: G (gutter spikes)

Multiple Answer Format

This was a common format in the past and may still appear in study materials produced prior to 2020. CLARB has removed this question format type from the Orientation Guide and **you will no longer encounter it on the LARE**. We have removed it from our materials.

7. Duties of the Landscape Architect during construction include:
- I. Insures compliance with the contract documents
 - II. Asserts control over methods of construction
 - III. Rules on the acceptability of materials
 - IV. Keeps the Owner informed of project status
- A. I and III only
 - B. I, II and III
 - C. I, III and IV
 - D. All of the above

Multiple Response Format

Instead of the Multiple Answer Format, CLARB has moved to an even more difficult alternative. For these questions, you may be given more than 4 possible choices, and asked to 'Select all that apply'. The question format will not give you any help with these! **CLARB has said that the answer will never be just one, and never be all.** So select two or more answers and just do your best.

There will also be questions that ask you to choose 2, choose 3, etc. For these questions, you may find it helpful to work through a process of strategic elimination. Are any answers obviously correct or incorrect? Narrow it down to the few that you are not sure of and then make your guess.

Below you'll find an example that asks you to evaluate a photograph. This is a format added in September 2007. It's very similar to evaluating a detail.



6. What, if anything is wrong with this stair? Select all that apply.

- A. Nothing. It's historic and thus exempt from code.
- B. Height of handrail is insufficient.
- C. Spacing between pickets is insufficient.
- D. Handrail extension at bottom of stairs is inadequate.
- E. No landing at top.
- F. Risers are not substantially uniform.
- G. Stair nosings do not meet code.
- H. Handrail alignment relative to stairs is illegal.

Answer: D, E, F, H

Use of Tables and Charts

It is possible that you will be required to develop answers by reading other types of tables or charts on any of the 4 sections of the LARE.

Examples:

- Population growth projections for longer range recreational planning
- A galvanic series table to avoid using incompatible metals
- The USDA soil texture triangle.

Interpreting soil boring information will most likely be tested in IAP and GDSW.

There is crossover between the sections, so it may be prudent to be familiar with all the LARE tables and charts. There may be a question in CDA that will require you to size timbers for (most likely) a wood deck using a chart.

There may also be a question on GDSW that where you will size a storm drain pipe using a nomograph which is based on the Manning Equation.

Advanced Item Types (AITs) in the performance sections (P&D and GDSW)

Under the 2012-2013 exam format, CLARB eliminated the old design and grading vignettes which used to take from 25 minutes to well over an hour to complete. Instead, they have substituted shorter, graphically-driven exercises that purport to test similar skills. These AIT questions may still take 15-20 minutes to complete, even though each is only worth 1 point. It is my completely unscientific opinion that with the move to require candidates to use an onscreen calculator and whiteboard, there may be many more AIT problems that require a shorter chain of calculations than the classic 2013 format.

The various forms that these questions take in P&D and GDSW will be covered in this section of the syllabus.

AITs generally consist of an introductory statement or question, followed by (usually) a plan view. Some of these have additional graphics or multiple choice answers included. The additional graphics are in an 'element well' to one side of the plan, or in pop up windows labeled Exhibits. We will look at some examples.

The graphics below are from CLARB's 2013 video 'Not Sure about LARE Sections 3 and 4?' which was produced by ASLA and CLARB to demonstrate the computerized format that was introduced at that time. This is still the only resource we have from CLARB for understanding how AITs work for the design and grading sections of the exam.

You may be able to find it on Youtube under the title 'ASLA LARE Video'.

Measurement

You cannot measure anything on the exam. If dimensions are critical, they will be given to you in the problem statement. CLARB has decided to use "units" as a measurement standard. Many study materials are still written in imperial format (foot-inch). For the actual exam, CLARB may express dimensions as units, or they may give you the number in both imperial and metric units if it is a critical design element like a curb (height is 6"/150 mm). Note that the exam will be written to be universal for North America, so while you may need to practice with inches in your studies, it is unlikely you will be asked to do inch calculations. If you work in the US, you should be familiar with decimal feet. These calculations are very similar to using metric units.

Measurement

Due to the fact that you will be unable to measure components in an item, dimensions will be provided to you should you need them for calculations.

- To avoid confusion between Imperial measurement (feet and inches) and Metric, many items will be dimensioned using a generic scale (**units**).
- Use the number of units to calculate specific measurements that may be needed to answer the item.
- Do not try to convert the "units" to either feet or meters to answer the item.

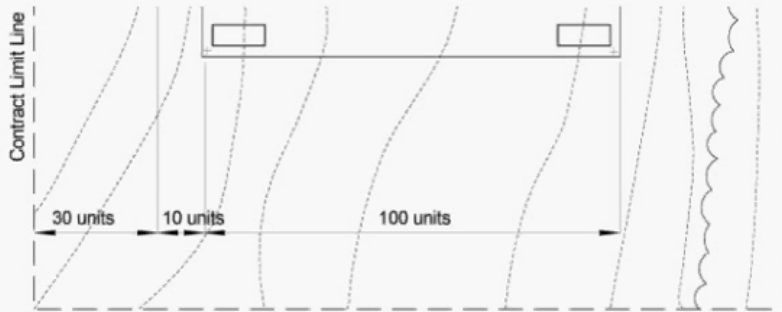

Select the **N**ext button to continue

Some graphical problems will have pop-up dialog windows with exhibits. (You can visit the CLARB website for a demonstration of the Exhibit function in the Demo Exam.)

Exhibits

In order to answer some of the items, you will need to consider additional information called exhibits.

- Should additional information be required the item will direct you to "**Refer to the exhibit(s)**".
- To see the exhibits, move your mouse cursor over the **Show Exhibit button** and click the left mouse button.
- This will result in a pop-up window appearing that contains one or more tabs of stimuli information that you will need to review prior to answering the item.

Show Exhibit

Prepare a grading plan for the proposed maximum. Runoff shall not flow onto the

20.6
21.0
21.5
21.9

Select the **N**ext button to continue

Some problems have multiple exhibits.

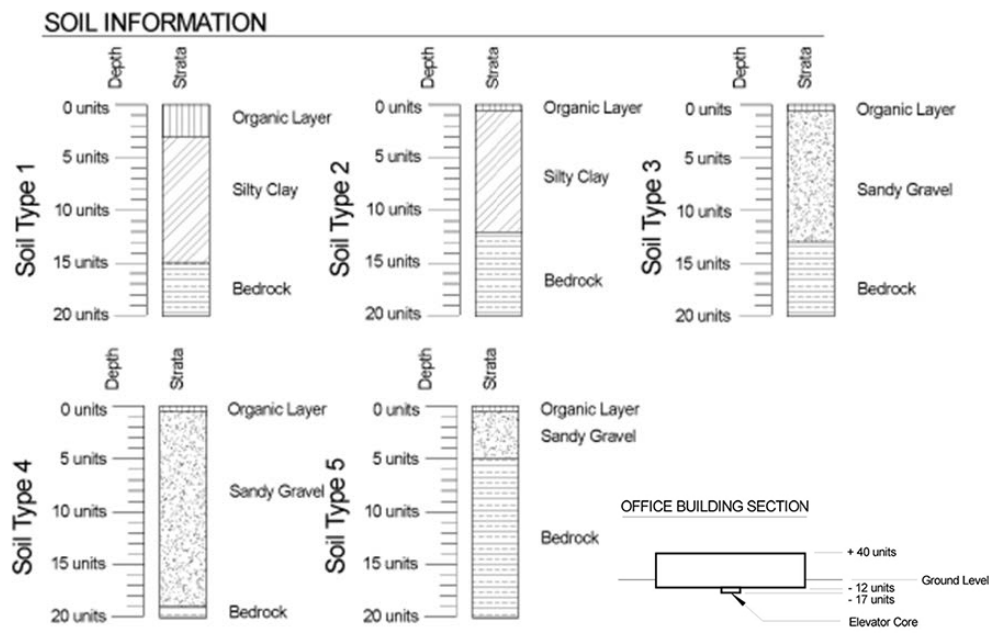
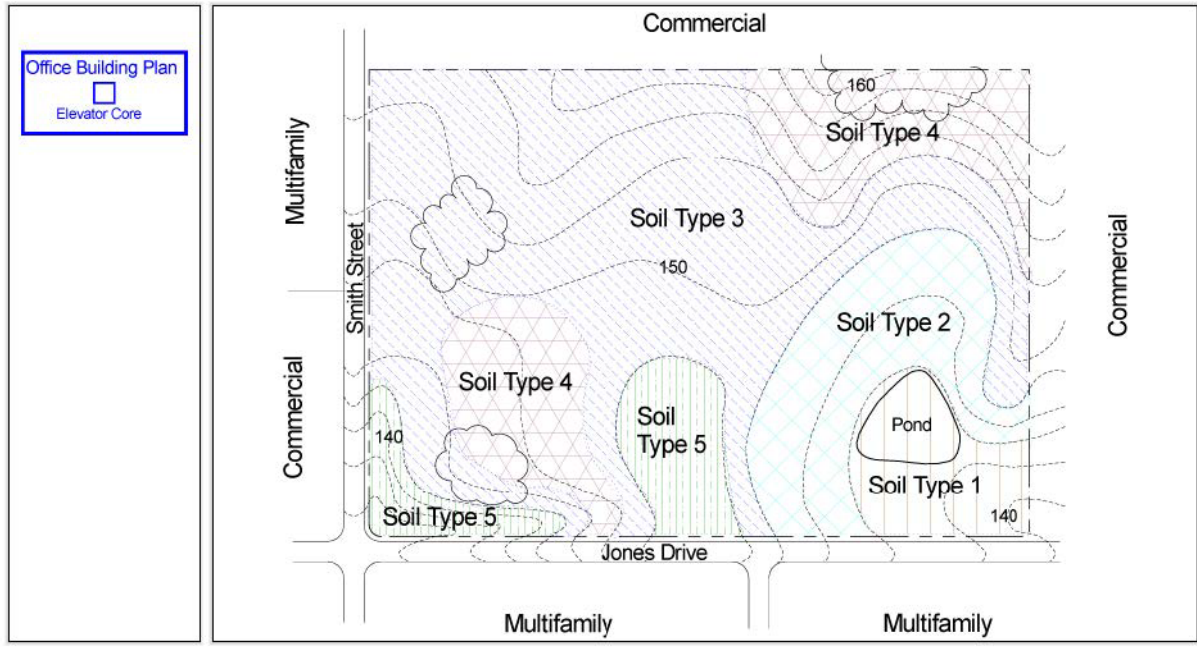

The soil borings above and the building section go with the plan view.

This particular problem is a drag and drop type. You select elements from a well and drag them into the correct location on the plan view.

Multiple Response Format

This question format will ask you to select answers from a list. Below is an example.

Evaluate the proposed site plan for a Nature Visitor Center and identify the items of circulation that are unsafe and/or incorrect. Choose three (3) that apply.

The site plan shows a Visitor Center building with a 'Drop-off' zone to its right. A 'Parking' area is located to the left of the building, with a 'One Way' arrow pointing towards the building. A 'Trail' is shown to the right of the building, leading to a 'Park' area. The site is bounded by 'Commercial' to the west, 'Residential' to the south, and 'Park' to the east. Contour lines are labeled with elevations: 92, 90, 88, 86, 84, 82, and 80. A 'Drop-off' zone is marked with an arrow pointing right. A 'Trail' is shown as a thick black line. 'Existing Trees (typ.)' are indicated by cloud-like shapes. A 'Shopping Center Parking Area' is located to the north of the site. A 'Residential' area is located to the south of Nature Park Drive. A 'Commercial' area is located to the west of the site. A 'Park' area is located to the east of the site. A 'Drop-off' zone is marked with an arrow pointing right. A 'Trail' is shown as a thick black line. 'Existing Trees (typ.)' are indicated by cloud-like shapes. A 'Shopping Center Parking Area' is located to the north of the site. A 'Residential' area is located to the south of Nature Park Drive. A 'Commercial' area is located to the west of the site. A 'Park' area is located to the east of the site.

- The parking area is on the wrong side of the Nature Visitor Center.
- The location of the accessible parking space.
- The parking area is located too close to the drop off zone.
- The primary vehicular circulation goes through the parking area.
- The parking spaces and driveway aisles are equal in dimension.
- Access to the site is from Nature Park Drive.
- There is an accessible route from the Visitor Center to the trail.
- There is no access from the Shopping Center Parking Area to the Nature Visitor Center.
- The circulation in the parking area is one way only.

You may encounter questions with more than 4 possible answers, and be asked to choose a specific number of correct answers; or you may be asked to 'choose all that apply'.

CLARB has provided direction that for 'Select All That Apply', the **correct set will never be just one answer, and will never be all of the answers.** This is a difficult question format.

Watershed or Topographic Analysis

Questions involving reading contours to determine watershed areas for some practical purpose like avoiding sensitive environments, pollution or stormwater control, or creating ponds or lakes can come up in any section of the LARE.

28. Refer to the exhibit(s). Utilizing the existing topography, identify the most appropriate location to construct an earthen berm to retain the largest volume of water with the least environmental impact. Construction is not permitted in the existing stream channels. *Select the best location for the earthen dam.*

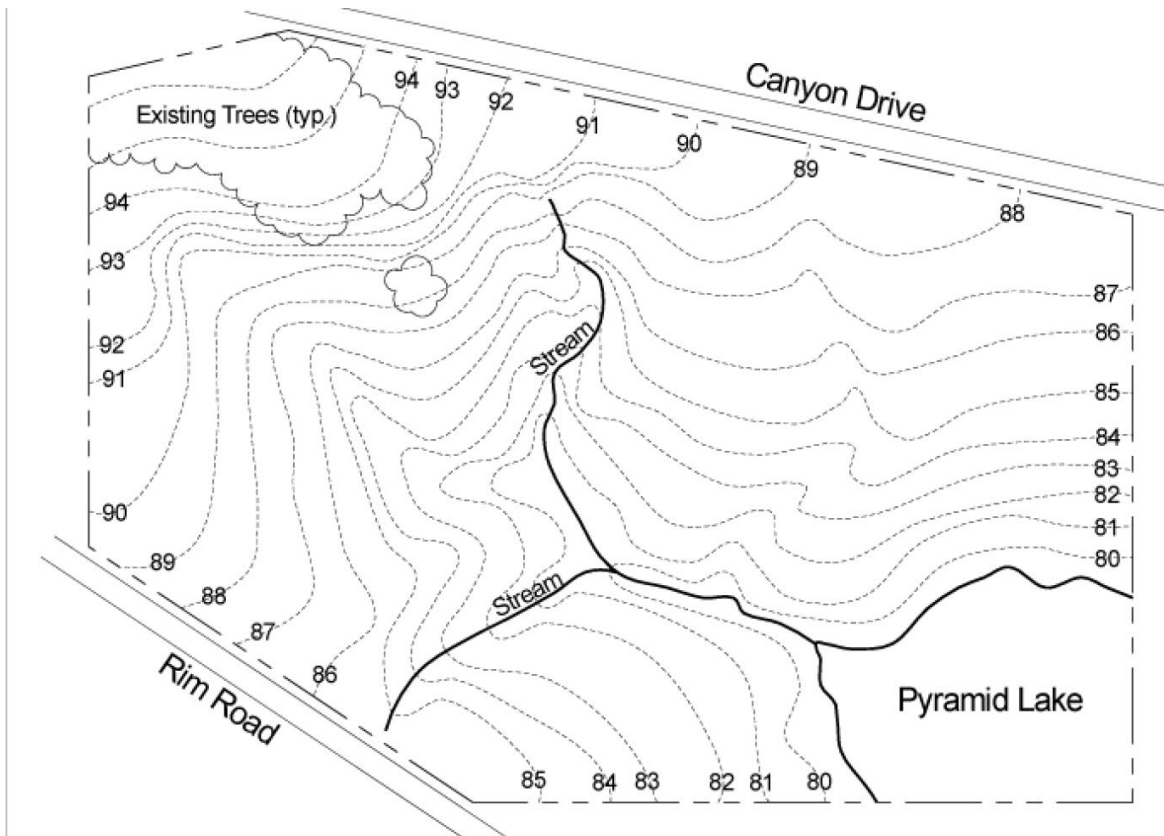

List and Box

A variation on the drag and drop format may ask you to select a number or a label from a list and place it in a box provided on a drawing. There will likely be more answers than boxes. You may need to use some answers more than once.

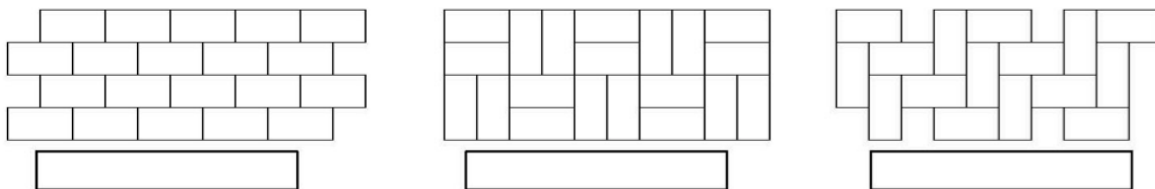

Label the three plan view paving patterns shown above from the list below.
 Which pattern would be the most stable if used as a flexible pavement with vehicular traffic?
 Which pattern would be the least stable?

- BASKET WEAVE
- ENGLISH BOND
- FLEMISH BOND
- HERRING BONE
- RUNNING BOND
- STACKED BOND
- TWEED

LEAST

MOST

Other variations on the drag and drop format may include dragging site plan elements onto a given parcel of land. You may be given a choice of orientation for some or all of the elements. Selecting the correct location as well as the correct orientation will be required to get the question correct.

Another variation is where you may be provided with bubble locations on the site (say four of them) and be asked to drag the correct label into each location. Obviously this should be a bit less complicated than the variation mentioned in the paragraph above.

Hot Spot Format

You will be asked to click on a location on a site using the computer mouse to show the correct placement of a small element such as a spot elevation or drain inlet. On P&D, you might be asked to identify the location on a site plan where the most dangerous vehicular-pedestrian conflict would be located.

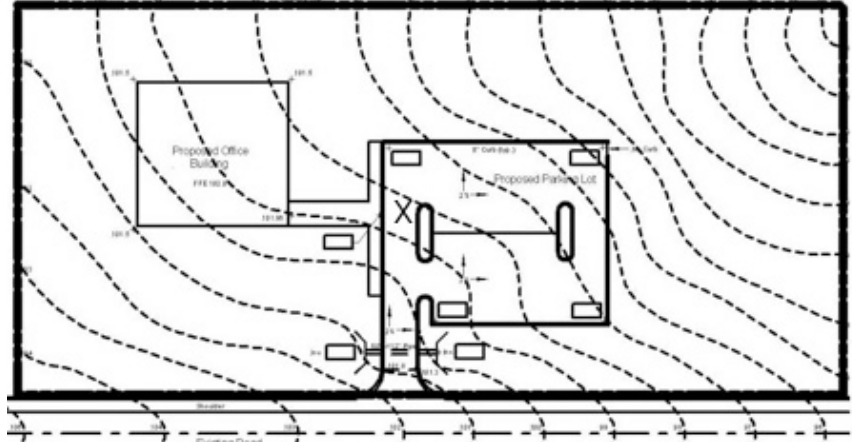

Review Screen

Instructions

Below is a summary of your answers. You can review your questions in three (3) different ways.

The buttons in the lower right-hand corner correspond to these choices:

Return to Exam: This choice takes you back to the beginning of the exam or back to where you stopped for a break.

Review Incomplete: This choice takes you through all the incomplete questions including unseen questions.

Review Marked: This option takes you through all the marked questions only. *(Click the checkbox to change the mark for review status.)*

You may also click on a question number to link directly to a specific question.

Please note:

You must **FINALIZE** your answers to questions you have already seen prior to taking a break. Previously seen items will be **LOCKED** after you return from your break. To start your break after you have finalized your answers click the Take a break button in the upper right-hand corner.

The **End Exam** button on the bottom left will end your exam and you **WILL NOT** be able to log back into the exam.

Section 1 (15 Questions)

<input type="checkbox"/> Question 1	Incomplete	<input type="checkbox"/> Question 2	Unseen	<input type="checkbox"/> Question 3	Unseen
<input type="checkbox"/> Question 4	Unseen	<input type="checkbox"/> Question 5	Unseen	<input type="checkbox"/> Question 6	Unseen
<input type="checkbox"/> Question 7	Unseen	<input type="checkbox"/> Question 8	Unseen	<input type="checkbox"/> Question 9	Unseen
<input type="checkbox"/> Question 10	Unseen	<input type="checkbox"/> Question 11	Unseen	<input type="checkbox"/> Question 12	Unseen
<input type="checkbox"/> Question 13	Unseen	<input type="checkbox"/> Question 14	Unseen	<input type="checkbox"/> Question 15	Unseen

End Exam CLARB Return to Exam Review Incomplete Review Marked

The Exam Interface

The exam interface has a review screen that you can toggle to at any time to see which questions you have flagged or not yet answered. Go to CLARB’s 2023 Demo Exam to see the current formats for these features.

- The computer has a clock which tells you how much time is remaining.
- The computer has a built-in calculator and a digital whiteboard that you will be expected to use. You can type text or draw sketches with your mouse in the whiteboard.
- The interface allows you to flag questions so that you can see you have not answered them. There is a master index screen you can check.
- It is possible to go back and change your answers.
- You do not have to answer the questions in order.

*****REMEMBER – as of Jan 2022, if you take a break, the portions of the exam that you have seen will be locked! Plan ahead to avoid taking a break!*****

OTHER CONSIDERATIONS

Inappropriate Content for the Section

You will likely encounter some questions that you did not expect to find on the specific section you are taking. Here is one from a CLARB sample test. It's a plant massing question, clearly a task performed during design (schematic or design development), NOT construction documentation. Yet this question was in a Section 4 practice test. What KSA is this question actually testing? There is a HSW issue hidden here.

34. Using the graphic provided, select the planting scheme that provides the most comfort and security for plaza users in a warm climate. *Select the best scheme.*

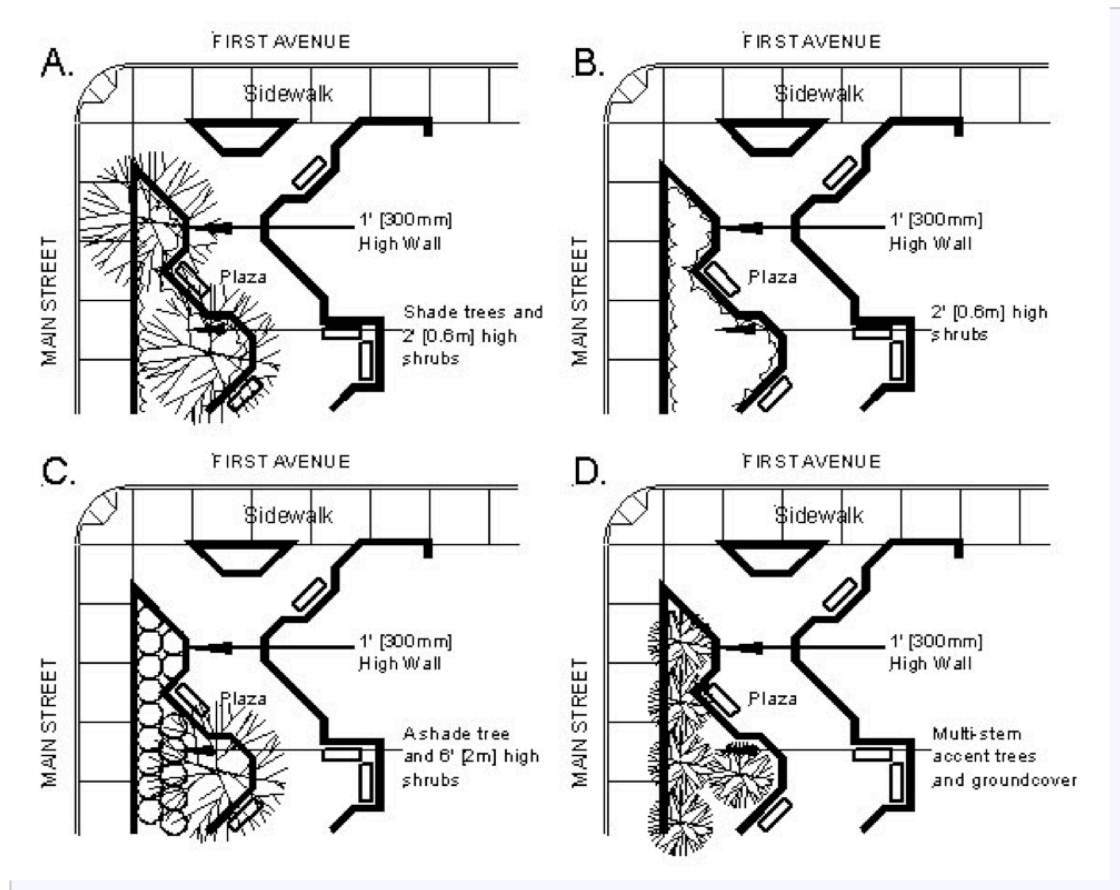

This question is about sight triangles at intersections, not planting design. You may also find that concrete questions pop up in all sections in various forms. Concrete testing is usually covered in CDA. Selection of color and finish might be in P&D, and questions about concrete drainage structures will be in GDSW.

Take Practice and Reference Material with a Grain of Salt

Just because something is in print, or some wag posted it to the internet does not mean it is true or accurate. Here is an example question for Section 4 prep from the 2012 ASLA LARE prep session.

WALKWAY WITH PIPE UNDERDRAIN

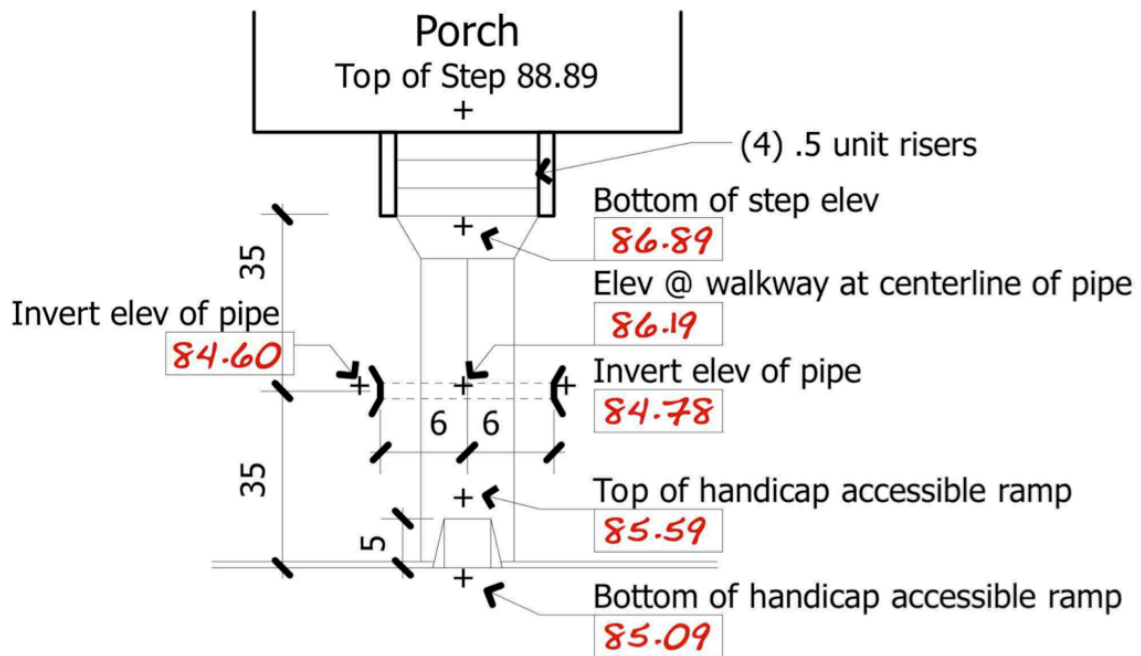

Given: Concrete on walkway .5 units thick, slope 2%
 .5 unit pipe to slope 1.5%
 with a minimum of 12" cover over pipe, including walkway

The spot elevation 85.09 at the bottom of the curb ramp is incorrect! It does not comply with ADA requirements.

The old PPI Section C practice vignettes (two 11x17 booklets) are full of errors. In particular, quite a few of the solutions given as "Passing" in those books have recommendations that would cause candidates to fail.

If you see something in print that doesn't seem right to you, take it as an opportunity to conduct further research into the topic and check with your study group. This will be a helpful learning experience.

TAKING THE LARE

Test Taking Tips

1. Read the problem statement carefully. This is of some importance because CLARB has been known to get tricky with the wording of some questions. Here's an example from a CLARB Practice Test:

Q: Despite a contract requirement to carry out site investigations prior to commencement of work, a contractor damaged a gas line. The gas line was not shown in the consultant's contract documents, but was on the survey prepared for the project. Who would most likely be responsible?

- A. The contractor
- B. The property owner
- C. The gas company
- D. The consultant and the contractor

Correct answer is D. Contractor failed to carry out the terms of the contract and thus was negligent. Consultant is liable because apparently the survey was not included in the construction drawing package.

2. Go through the section quickly. Answer those questions where you are sure of the answers. Then go through again, answering questions where you have been able to reduce the answer to one of two possibilities. Finally, answer all of the remaining questions.

3. Answer all of the questions. There is no penalty for a wrong guess.

4. Don't get hung up on a difficult question and waste valuable time. Go on and come back to it later. Save the hardest questions for last.

5. This method actually helps with the harder questions. Sometimes clues to questions you can not answer may be found in other questions in the section.

6. Consider saving questions that involve using charts & tables, or a set of involved calculations for near the end of the section.

7. You are allowed to go back to questions you have skipped.

8. On site planning problems, you may need to consider slope or elevation information, vegetation, existing water features such as streams or lakes, hazards, wildlife habitat, views, access points, internal circulation, soils, and adjacent land uses.

The basic idea behind all of these tips is:

- Building your confidence through positive reinforcement.
- Getting the maximum number of questions answered in the time allotted.

Dealing with Anxiety

Everyone will have anxiety. I have heard that for some candidates, this factor alone makes it extremely difficult to perform well on test day. You are not alone if this is you! I have assembled some strategies for anxiety management. Maybe one of them will work for you. I'd love to hear how you dealt with nerves if you have an approach we have not listed here.

- Find low-stakes versions of the situation you are dreading and get comfortable in them. I know accomplished professional musicians who get ready for a big performance by going to totally amateur small open mike nights. They just seek out many different opportunities to be on stage, and give

themselves the time to find comfort in that place. As you work on practice problems, replicate the testing environment for your practice exams as much as possible. Set a timer, use the computer calculator and work from a pdf on screen with a notepad, sit in an uncomfortable chair in an unfamiliar setting. This is a good tip for everyone.

- Before the exam, find ways to imagine being in the exam but being calm and feeling well-prepared. Athletes do this all the time and it measurably improves performance. This technique should be something you do often - maybe at night as you are waiting to fall asleep. There's a lot on athletic visualization, here's one article: <https://www.peaksports.com/sports-psychology-blog/sports-visualization-athletes/>
- Be kind to yourself. You are showing up! Even though this is difficult, give yourself credit for taking this exam on and investing in your future. Try not to be too invested in the outcome – focus on all the benefits of studying and learning as you prepare and network with other fantastic professionals.
- You may be able to shift your feelings of anxiety to curiosity, which is also a form of attention but has much less painful side effects. It gives your mind something to do. See if you can think less about how awful it will be if you don't get the outcome you need, and concentrate instead on the amazing human comedy that this is. You will be in a very unusual environment surrounded by people taking many different kinds of tests. What is the proctor's story? How have they set up the room to work, or what is comically missing? What crazy impossible vocabulary word that no one has ever heard of will show up this time?
- Paradoxically I find that sometimes practicing radical acceptance of the possibility I might fail makes it possible to succeed. Buddhist teacher Tara Brach has great lectures on this tool. I know it seems backwards - but it works for me, helps defuse the charge on the outcome. Several students have reported good results working with meditation as a mood management tool as well.
- If you feel your anxiety rising, try not to judge yourself. Think of it as an opportunity to practice recentering through breathing, visualization, counting backwards, or imagining your happy place. If anxiety arises while you are studying or doing practice exams, be happy! This is a great training opportunity! See if you can practice calming yourself before test day and build that skill.

Test Do's and Dont's

If you have not reserved your spot at a testing center yet, do so as quickly as possible. PSI does not have as many test centers as Pearson used to have.

CLARB has encouraged candidates to contact them directly if you are having a hard time finding a seat. They will work with their testing partners on your behalf to find a scheduled seat for you. I hope this will become a smoother process soon.

Be prepared for testing center drama and computer-related glitches. If this happens, try to stay cool. Otherwise you will probably hurt your performance. Some test centers during 2020 were pretty sketchy in terms of the facility and their ability to remember what you are entitled to have as a test candidate. If there is a problem with your computer, or if you do not have access to the onboard whiteboard and calculator, do not begin until the test center resolves the issue.

The updated Candidate Orientation Book also recommends that if you have any problems at your test center on the day of the exam that the proctors are not resolving to your satisfaction, you should contact CLARB immediately **before you leave the test center**. They are actively working to try to fix testing problems. I do know several students who have been in this position. It can't hurt to have CLARB's contact info written on a slip of paper with your ID. They are open 9-5 Eastern Standard time. Once more:

CLARB Main Phone (in Virginia): 1 (571) 432-0332

- Do not panic. This is a recipe for disaster. You must maintain a calm and rational demeanor for the full test period. Any overly emotional response to a question or situation such as fear, frustration, resentment, anger, outrage, etc., will only lessen your chances of successfully completing the exam. Stay calm and focused. If necessary, take a moment to close your eyes, take some deep breaths, relax and regain focus.
- Taking a serious exam like the LARE requires a mindset unlike your usual state of mind. Practice taking timed mini-exams and familiarizing yourself with the accompanying feelings.
- It is important for you to take advantage of every break you can get. The night before the exam starts, get some exercise and plenty of rest. If you are taking multiple sections, after each full day of the exam, limit your studying to reviewing your notes, and do not cram to learn new material. Focus on eating right, resting, and moderate exercise.
- The LARE is a marathon, not a sprint. You have multiple opportunities to take the exam each year. You still should get plenty of sleep and avoid stressing out about the sections you just took or the ones you'll be taking tomorrow. Focus on the now.
- As you take the exam, be careful that you have actually clicked on the answer you intend. It is all too easy to click the wrong box and move on without noticing the error. The calculator is also laggy, according to recent candidates. Go slowly and methodically in order to go fast.

LARE Qualifier Words

CLARB has a tendency to use words in their questions AND answers that may affect what the question is asking or whether the answer satisfies the wording of the question. I call these qualifier words. It is very important not to rush your reading of questions/answers as this can lead to unfortunate errors. Some examples of these words are given below in a list. During the webinar, we practice noticing how wording can affect the correct answer for specific problems/questions.

All	Always	Shall
Must	Only	Never
Not	At Least	No More Than
No Greater Than	No Less Than	Minimum
Maximum	Equal to	Greater Than
Less Than	Increase	Decrease

OTHER IDEAS SUGGESTED BY SUCCESSFUL CANDIDATES

- Stay near the test site at a hotel or a friend's place in order to avoid commuter and traffic stress and the possibility of being late to a session. In any event, do not be late. This strategy may also help you with the next problem to be solved...
- Think hard about travel logistics ahead of time. You may not be given a safe place to store coats, wallets, bags, or backpacks – you should not bring these items if possible. This is a hardship, ironically, for people who rely on public transportation. PSI will provide some kind of coat accommodation – back

of your chair or a public coatrack? A plastic bag over your chair? Unclear. They will allow you to keep car keys on your person.

- Map out a test preparation strategy. For example:
 - 8-10 weeks prior to the exam: Develop game plan for study. Assemble study materials and get organized. Line up your study partner or group, the more diverse in geography and experience the better!
 - 4 weeks prior to the exam: Focus in your study on those areas you've identified as weaknesses.
 - 2 weeks prior to the exam: Finish up your original study and begin review of material to refresh and reinforce.
 - 1 week prior to exam: Light study only. Concentrate on mental preparation and getting rested and relaxed. Think about preparations for your exam, especially if you're taking it remotely from home.
- Take increasingly longer timed practice tests. Take them with your study group, then check each other's tests and discuss. If possible, make the final test similar in length to the actual exam sections.
- Have a go at writing some test questions to swap within your study group. This can be an excellent learning tool as well as be helpful to your colleagues. Looking at the KSAs and thinking about how they might be tested is great practice for assessing actual test questions during the exam.

ETHICS

Your study group should establish ground rules that all members will only share information and study content with each other that does not violate the recently updated version of the L.A.R.E. Candidate Agreement. The LARE Candidate Agreement (reproduced below) makes it clear that you cannot share either verbatim or substantially similar exam topics, content or questions, whether in writing or verbally, that were copied, recalled or reconstructed from any LARE exam that you or anyone else may have taken. As you can read in the Candidate Agreement, reproduced in its entirety below, CLARB prohibits you from:

describing questions, answer choices, passages, images or graphics from any Section of the L.A.R.E.; identifying terms or concepts contained in exam questions or responses; sharing answers to questions; referring others to information I saw on the exam; reconstructing a list of topics on the test; and soliciting or discussing exam questions, answer choices, passages, images, graphics, or topics in person, through telephonic or electronic communication, or on Internet chat rooms, social media, private or public groups, message boards, forums, or through any other means.

If you become aware that anyone in your study group, or anyone else for that matter, is sharing copied, recalled or reconstructed LARE content, in whole or part, you are obligated to report that to CLARB, as provided in the Candidate Agreement:

I agree that if I receive or have access to information or material in any form and from any source, including but not limited to email, instant messages, text messages, website content, social media posts, electronic bulletin boards, Internet-based groups, digital or electronic files and/or paper documents, that I reasonably believe contain confidential L.A.R.E. Content, or has been represented to contain L.A.R.E. Content, I will immediately report its existence to CLARB via email.

If CLARB becomes aware that any candidate violated these rules, CLARB may, at their discretion, throw out impacted test scores as 'indeterminate' (this category is a catchall for impropriety, statistical anomaly, or 'any other basis to question the test score's validity'), conduct an investigation or even take legal action against anyone who participated in misconduct.

Our standards for webinars will comply with CLARB's rules, similar to the discussions on the Google LARE group. We will review the topics listed in the Orientation Guide as completely as possible, based on the reference materials listed and some supplemental reference materials that we recommend.

It is our professional duty to uphold the integrity and fairness of the exam.

Please refer to CLARB's LARE Orientation Guide for the most current LARE Candidate Agreement. It is lengthy and has been changing frequently in 2021-2023.

ORGANIZING YOUR STUDY TIME

It is best to set up a regular study schedule. Many short sessions are better than a few cram sessions. Can you devote 2-3 hours a week to study, in 30-60 min segments? Block this time out on your calendar and make it realistic given your work and family commitments.

Each session:

- Start with something easy and pleasant – 5-10 minutes of flashcards is a good beginning.
- 15-20 minutes of reading – review CLARB's reference books first and then our additional ones. Skim for graphics and vocabulary if you have a hard time focusing on reading.
- 30 minutes of grading practice - Do one of our AITs or a grading exercise from Valerie Aymer's new book or the old Morrison Media/PPP Section E vignettes. Learning to draw contours is important as well as practicing spot grade calculations.

Do you have exam anxiety? We highly recommend some regular mindfulness practice to defuse the emotional charge around this upcoming event. I have been experimenting with the online course 'Waking Up' but also can recommend free lectures by Tara Brach available online. Regular exercise, relaxing with your family or pets, or forest bathing may work too. Be kind to yourself. <3

ORGANIZING A SUCCESSFUL STUDY GROUP

We know that working with others can greatly increase your skill and understanding. We are all busy and a group needs organization. Here are some suggestions for making the most of your cohort and working together towards being well-prepared for exam day.

- A study group needs to be organized just like any project team. Someone needs to take the lead to start, but there are many online resources that can make this easier. Use Google Sheets to organize contact information. Use shared folders like Google Drive or Dropbox to share study resources. Try to find a few people whose experience is different than yours, by region or by specialization.
- It is often easiest to divide into groups by time zone.
- Schedule regular meeting times. It's okay if you can't make every session but commit to a regular time and set up a Slack channel or a Zoom calendar invitation so that you won't let it slide to the bottom of your to-do list.
- For each meeting, it works well to divide your time into two or three parts. Maybe start with a review of a reference document, and then move on to doing practice tests. Structure your time and don't worry about perfection.
- Divide up time-consuming tasks like reading reference books. Take turns summarizing what you think is most important from the books on CLARBs and our list.

- Do practice exams before you meet, review them together and talk about what makes an answer right or wrong. Your study group will have invaluable diversity in skills and experience and you will learn a lot by just talking about practice questions – especially AIT questions.
- Use CLARB’s online Demonstration Exam tools to do calculations and make notes during your practice sessions. Can you build comfort and speed using these tools before test day? Share tips and tricks.
- Write practice questions for each other. If you struggle with being able to see what the purpose of a question is, or you get overwhelmed by question details, you may find it very useful to try making a question yourself. Remember questions usually have one correct answer and several ‘distractors’ that are not quite correct. How would you write a fair but difficult question? What details would you include to make one of the answers most correct?
- Some study groups make summary sheets or flashcard decks. I have heard that the process of doing this for yourself is more valuable than just using one someone else has made. Make use of Quizlet or Anki to build vocabulary and increase your comprehension speed.
- Provide each other with positivity and support. Follow up after test day and encourage each other to not take a tough question or test day too personally.
- After test day you may find that your study cohorts become long-term friends and resources. I did. Don’t be afraid to stay in touch and ask each other technical questions as you continue on with your professional development over the years.

